

VORTRONIC® ELECTROSTATIC FILTER SERIES

- Clears air of tobacco smoke, dust, pollen, etc., in bedrooms, childrens rooms, offices, shops, pubs, etc.
- Electrostatic filter has strong air-purification action which attracts even very small particles like a magnet.
- Activated carbon fibre filter which needs periodic replacement removes odours effectively. The Model 200T has a supplementary granular active-carbon filter.
- Three speeds provide silent operation which makes this unit suitable for night time use.
- Safe operation. Unit turns off whenever the filter door is opened or when the filter is saturated (indicator light turns on).
- Complies with the CEI EN 60335-2-65 standard.
- Indicator lights show GREEN (for ON), YELLOW (for ionising) and RED (for saturated filter).
- Can be used with or without ioniser.
- Table models 50 and 100 can also be wall-mounted using the optional kit. The 200T model is supplied with wheels to enable it to be easily moved from room to room.
- Floor stand included.







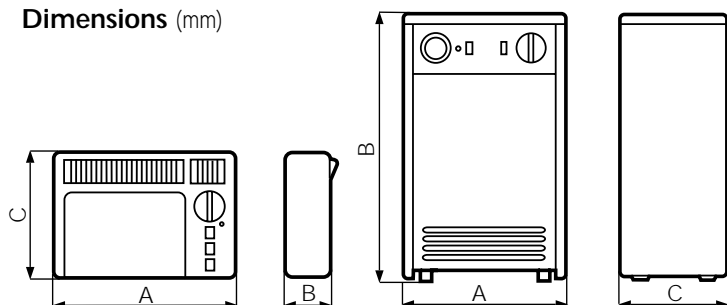

Design: F. Trabucco & Associates



Dimensions (mm)



Vortronic	A	B	C
50	420	120	315
100	540	120	315
200 T	425	800	370

Product	Code	Room volume m ³	V ~ 50 Hz	W	A	Lw dB(A)			Lp dB(A) 3 m			Approvals	kg	Insulation
						1 st speed	2 nd speed	3 rd speed	1 st speed	2 nd speed	3 rd speed			
 Vortronic 50	25083 25086*	50	230	36	0.22	41	50	55	27.5	35.8	39.7		4.8	 cl.I
 Vortronic 100	25084 25087*	100	230	36	0.22	42	50	55	27.7	35.6	40.4		5.6	 cl.I
 Vortronic 200 T	25085 25088*	200	230	72	0.38	36	55	56	24.9	40.4	41.8		30	 cl.I

* Available only in UK



Particularly useful for bedrooms.



Also useful in smoking rooms.



The 200 T model is designed for larger rooms in community buildings or businesses.



Washable metallic pre-filter.



Washable electrostatic filter.

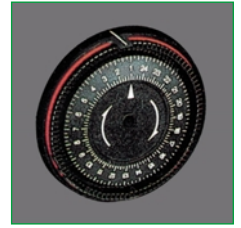



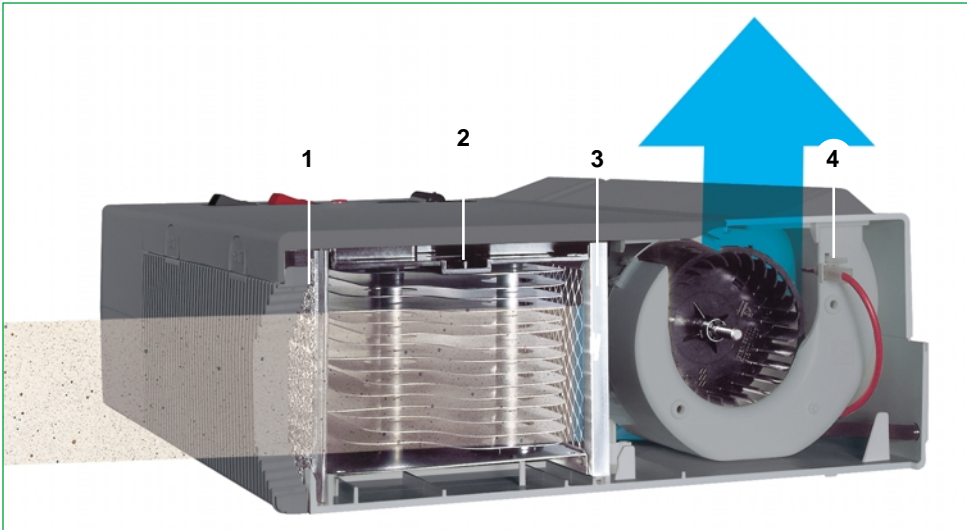

The model 200 T is supplied with a daily programmer with 15 minute settings (min).



- ❶ Metallic pre-filter traps particles and dust.
- ❷ Electronically-controlled electrostatic filter eliminates air impurities.
- ❸ Activated-carbon filter eliminates most odours.
- ❹ Ionising electrode brushes improve and biologically revitalise air quality.

Accessories

Vortronic			50	100	200 T
	Optional wall-mounting kit	code	22014	22014	–
	Activated-carbon fibre filter (6 per package)	code	22009	–	–
	Activated-carbon fibre filter (6 per package)	code	–	22013	–
	Activated-carbon fibre filter (3 per package)	code	–	–	22086
	Granular activated-carbon filter (4 per package)	code	–	–	22083