



### Compact (Purmo C)\*

Radiatoare-panou PURMO Compact cu panouri de încălzire profilate și cu elemente de convecție. Sunt prevăzute cu protecții laterale și cu protecție superioară de tip grătar. Patru racorduri cu filet interior G ½" care permit racordare la dreapta sau la stânga.

#### date tehnice

- Material : tablă de oțel de calitate superioară de ambutisare adâncă cu conținut scăzut de carbon laminată la rece FeP0 1 conform EN 10130
- Grosimea nominală a tablei : panoul de încălzire - 1,25 mm;  
elementele de convecție - 0,50 mm
- Distanța între canalele verticale cu apă : 33,3 mm
- Racorduri : 4 x G ½" laterale
- Presiunea de lucru : 10 bari
- Temperatura maximă : 110 °C
- Presiunea de probă : 13 bari
- Culoare : albă RAL 9016, alte culori din paletă la comandă
- Accesorii : dispozitiv de fixare, dop, ventil de aerisire în dotare.



\* denumirea anterioară a radiatorului

## vedere laterală

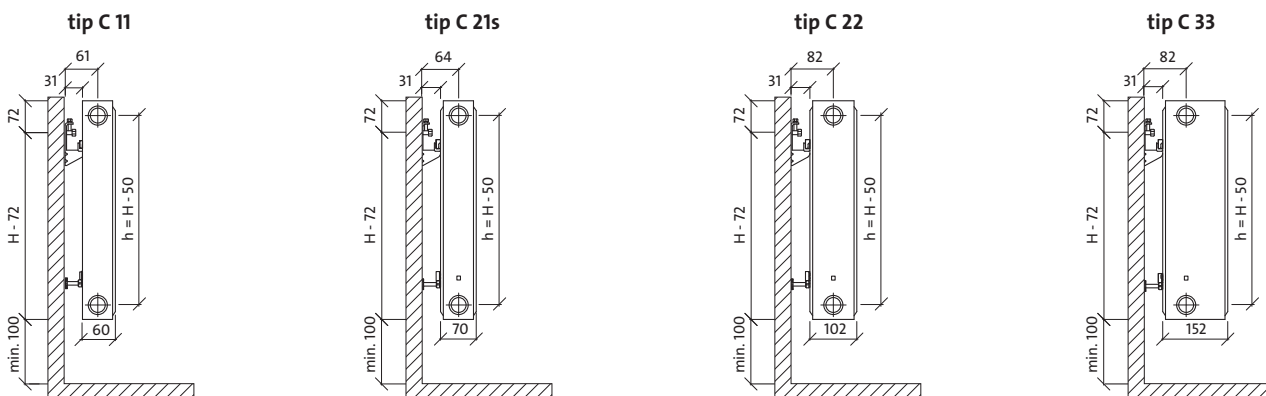

## vedere din față

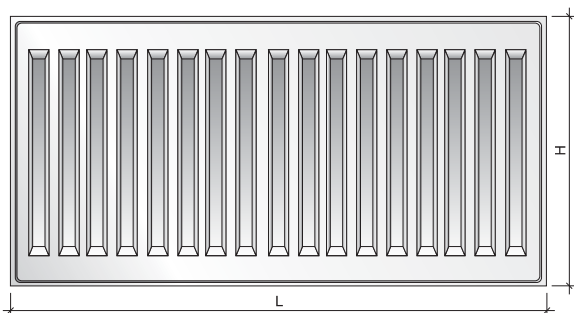

## vedere din spate

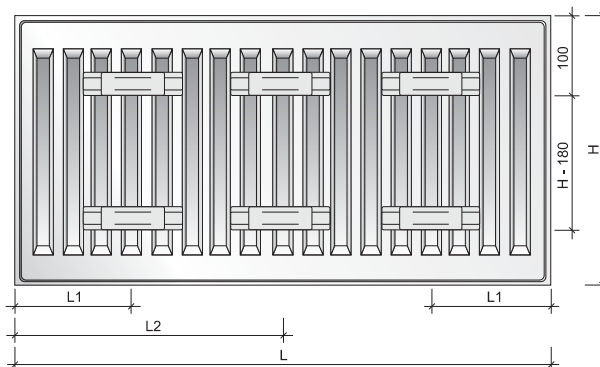

## capacitate, masă și distanțe de montaj

capacitate : l/m

înălțime tip	300	450	500	550	600	900
11	1,7	2,3	2,6	2,8	3,0	4,4
21s	3,4	4,8	5,2	5,7	6,2	8,9
22	3,4	4,8	5,2	5,7	6,2	8,9
33	5,0	7,0	7,7	8,2	9,0	13,0

masă : kg/m

înălțime tip	300	450	500	550	600	900
11	9,7	14,4	16,0	17,8	19,1	28,6
21s	13,7	21,3	23,8	26,1	28,8	43,9
22	15,7	24,3	27,2	29,9	32,9	50,1
33	25,0	37,4	41,5	46,7	49,8	74,6

distanțe de montaj : mm

tip	C 11		C 21s, C 22, C 33		
	L	L1	L2	L1	L2
400-1600	117	-	133	-	-
1800	117	917	133	900	-
2000	117	1017	133	1000	-
2300	117	1150	133	1150	-
2600	117	1317	133	1300	-
3000	117	1517	133	1500	-

## racordare recomandată

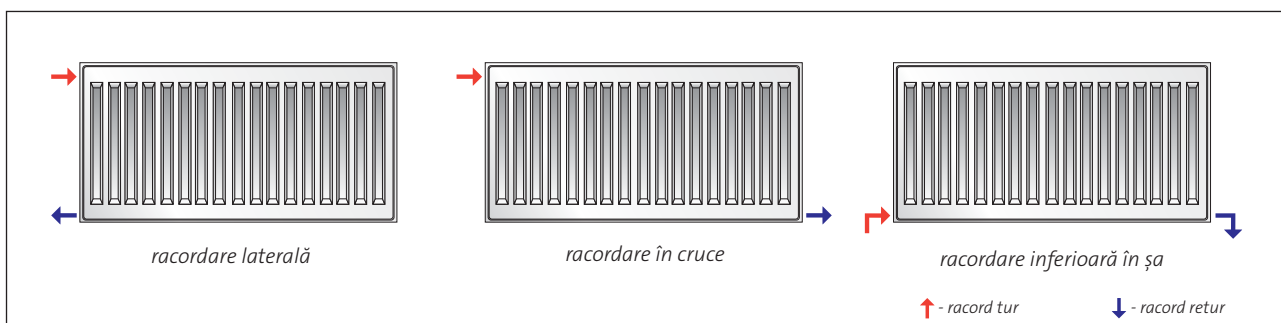



**PURMO C 11**

CODUL COMENZII : **C11XXXXYYY**  
 EXEMPLU : **C116001200**  
 abreviere denumire  
 tip  
 înălțime  
 lungime

lungime [mm]	parametri $t_z / t_p / t_i$	înălțime [mm]					
		300	450	500	550	600	900
400	75/65/20°C	<b>218</b>	<b>316</b>	<b>347</b>	<b>378</b>	<b>407</b>	<b>571</b>
	70/55/20°C	175	253	278	302	326	456
500	75/65/20°C	<b>273</b>	<b>395</b>	<b>434</b>	<b>472</b>	<b>509</b>	<b>714</b>
	70/55/20°C	219	317	348	378	407	571
600	75/65/20°C	<b>328</b>	<b>474</b>	<b>521</b>	<b>566</b>	<b>611</b>	<b>856</b>
	70/55/20°C	263	380	417	454	489	685
700	75/65/20°C	<b>382</b>	<b>553</b>	<b>608</b>	<b>661</b>	<b>713</b>	<b>999</b>
	70/55/20°C	307	443	487	529	570	799
800	75/65/20°C	<b>437</b>	<b>632</b>	<b>694</b>	<b>755</b>	<b>814</b>	<b>1142</b>
	70/55/20°C	350	506	556	605	652	913
900	75/65/20°C	<b>491</b>	<b>711</b>	<b>781</b>	<b>850</b>	<b>916</b>	<b>1284</b>
	70/55/20°C	394	570	626	680	733	1027
1000	75/65/20°C	<b>546</b>	<b>790</b>	<b>868</b>	<b>944</b>	<b>1018</b>	<b>1427</b>
	70/55/20°C	438	633	695	756	815	1141
1100	75/65/20°C	<b>601</b>	<b>869</b>	<b>955</b>	<b>1038</b>	<b>1120</b>	<b>1570</b>
	70/55/20°C	482	696	765	832	896	1255
1200	75/65/20°C	<b>655</b>	<b>948</b>	<b>1042</b>	<b>1133</b>	<b>1222</b>	<b>1712</b>
	70/55/20°C	526	760	834	907	978	1369
1400	75/65/20°C	<b>764</b>	<b>1106</b>	<b>1215</b>	<b>1322</b>	<b>1425</b>	<b>1998</b>
	70/55/20°C	613	886	973	1058	1141	1598
1600	75/65/20°C	<b>874</b>	<b>1264</b>	<b>1389</b>	<b>1510</b>	<b>1629</b>	<b>2283</b>
	70/55/20°C	701	1013	1113	1209	1304	1826
1800	75/65/20°C	<b>983</b>	<b>1422</b>	<b>1562</b>	<b>1699</b>	<b>1832</b>	<b>2569</b>
	70/55/20°C	788	1140	1252	1361	1467	2054
2000	75/65/20°C	<b>1092</b>	<b>1580</b>	<b>1736</b>	<b>1888</b>	<b>2036</b>	<b>2854</b>
	70/55/20°C	876	1266	1391	1512	1630	2282
2300	75/65/20°C	<b>1256</b>	<b>1817</b>	<b>1996</b>	<b>2171</b>	<b>2341</b>	<b>3282</b>
	70/55/20°C	1008	1456	1599	1739	1874	2625
2600	75/65/20°C	<b>1420</b>	<b>2054</b>	<b>2257</b>	<b>2454</b>	<b>2647</b>	<b>3710</b>
	70/55/20°C	1139	1646	1808	1965	2119	2967
3000	75/65/20°C	<b>1638</b>	<b>2370</b>	<b>2604</b>	<b>2832</b>	<b>3054</b>	<b>4281</b>
	70/55/20°C	1314	1899	2086	2268	2445	3424

Puterea termică a radiatoarelor (W) în conformitate cu EN 442 pentru parametrii 75/65/20°C și 70/55/20°C.

[W/m] 90/70/20°C	686	994	1093	1189	1283	1800
coeficient n	<b>1,2981</b>	<b>1,3048</b>	<b>1,3070</b>	<b>1,3093</b>	<b>1,3115</b>	<b>1,3170</b>

radiator la comandă

CODUL COMENZII : **C21s**XXXXYYY  
 EXEMPLU : C21s**600**1200

abreviere denumire  
 tip  
 înălțime  
 lungime

PURMO C 21s





lungime [mm]	parametri t <sub>z</sub> / t <sub>p</sub> / t <sub>i</sub>	înălțime [mm]					
		300	450	500	550	600	900
400	75/65/20°C	304	424	462	500	536	744
	70/55/20°C	245	340	370	400	428	593
500	75/65/20°C	381	530	578	625	670	931
	70/55/20°C	306	425	463	500	535	741
600	75/65/20°C	457	636	694	749	804	1117
	70/55/20°C	367	510	556	600	643	890
700	75/65/20°C	533	742	809	874	938	1303
	70/55/20°C	429	595	648	699	750	1038
800	75/65/20°C	609	848	925	999	1072	1489
	70/55/20°C	490	680	741	799	857	1186
900	75/65/20°C	685	954	1040	1124	1206	1675
	70/55/20°C	551	765	833	899	964	1334
1000	75/65/20°C	761	1060	1156	1249	1340	1861
	70/55/20°C	612	850	926	999	1071	1483
1100	75/65/20°C	837	1166	1272	1374	1474	2047
	70/55/20°C	674	935	1019	1099	1178	1631
1200	75/65/20°C	913	1272	1387	1499	1608	2233
	70/55/20°C	735	1020	1111	1199	1285	1779
1400	75/65/20°C	1065	1484	1618	1749	1876	2605
	70/55/20°C	857	1190	1296	1399	1499	2076
1600	75/65/20°C	1218	1696	1850	1998	2144	2978
	70/55/20°C	980	1360	1482	1599	1713	2372
1800	75/65/20°C	1370	1908	2081	2248	2412	3350
	70/55/20°C	1102	1530	1667	1799	1928	2669
2000	75/65/20°C	1522	2120	2312	2498	2680	3722
	70/55/20°C	1225	1700	1852	1999	2142	2965
2300	75/65/20°C	1750	2438	2659	2873	3082	4280
	70/55/20°C	1408	1955	2130	2298	2463	3410
2600	75/65/20°C	1979	2756	3006	3247	3484	4839
	70/55/20°C	1592	2210	2407	2598	2784	3855
3000	75/65/20°C	2283	3180	3468	3747	4020	5583
	70/55/20°C	1837	2550	2778	2998	3213	4448

Puterea termică a radiatoarelor (W) în conformitate cu EN 442 pentru parametrii 75/65/20°C și 70/55/20°C.

[W/m] 90/70/20°C coeficient n	954 1,2803	1333 1,3008	1456 1,3076	1575 1,3145	1691 1,3213	2356 1,3390
----------------------------------	---------------	----------------	----------------	----------------	----------------	----------------

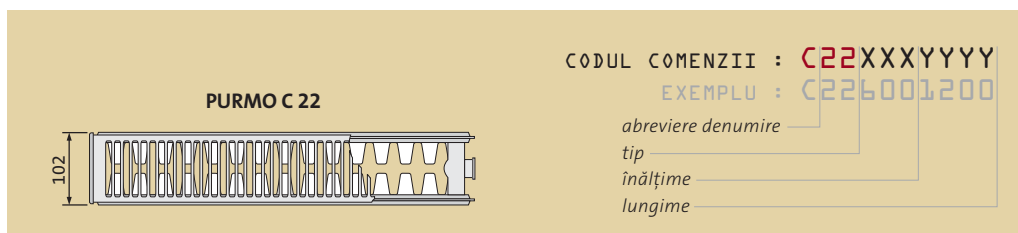
radiator la comandă



lungime [mm]	parametri $t_z / t_p / t_i$	înălțime [mm]					
		300	450	500	550	600	900
400	75/65/20°C	384	539	588	636	684	955
	70/55/20°C	308	430	469	508	545	759
500	75/65/20°C	481	674	735	796	855	1 194
	70/55/20°C	385	538	587	635	681	949
600	75/65/20°C	577	808	882	955	1 025	1 433
	70/55/20°C	462	646	704	762	817	1 138
700	75/65/20°C	673	943	1 029	1 114	1 196	1 672
	70/55/20°C	539	753	822	888	954	1 328
800	75/65/20°C	769	1 078	1 176	1 273	1 367	1 910
	70/55/20°C	616	861	939	1 015	1 090	1 518
900	75/65/20°C	865	1 212	1 323	1 432	1 538	2 149
	70/55/20°C	693	969	1 056	1 142	1 226	1 707
1000	75/65/20°C	961	1 347	1 470	1 591	1 709	2 388
	70/55/20°C	770	1 076	1 174	1 269	1 362	1 897
1100	75/65/20°C	1 057	1 482	1 617	1 750	1 880	2 627
	70/55/20°C	846	1 184	1 291	1 396	1 499	2 087
1200	75/65/20°C	1 153	1 616	1 764	1 909	2 051	2 866
	70/55/20°C	923	1 291	1 408	1 523	1 635	2 277
1400	75/65/20°C	1 345	1 886	2 058	2 227	2 393	3 343
	70/55/20°C	1 077	1 507	1 643	1 777	1 907	2 656
1600	75/65/20°C	1 538	2 155	2 352	2 546	2 734	3 821
	70/55/20°C	1 231	1 722	1 878	2 031	2 180	3 035
1800	75/65/20°C	1 730	2 425	2 646	2 864	3 076	4 298
	70/55/20°C	1 385	1 937	2 112	2 285	2 452	3 415
2000	75/65/20°C	1 922	2 694	2 940	3 182	3 418	4 776
	70/55/20°C	1 539	2 152	2 347	2 538	2 725	3 794
2300	75/65/20°C	2 210	3 098	3 381	3 659	3 931	5 492
	70/55/20°C	1 770	2 475	2 699	2 919	3 133	4 363
2600	75/65/20°C	2 499	3 502	3 822	4 137	4 443	6 209
	70/55/20°C	2 001	2 798	3 051	3 300	3 542	4 932
3000	75/65/20°C	2 883	4 041	4 410	4 773	5 127	7 164
	70/55/20°C	2 309	3 229	3 521	3 808	4 087	5 691

Puterea termică a radiatoarelor (W) în conformitate cu EN 442 pentru parametrii 75/65/20°C și 70/55/20°C.

[W/m] 90/70/20°C	1211	1701	1857	2012	2163	3033
coeficient n	1,3094	1,3226	1,3270	1,3314	1,3358	1,3561

radiator la comandă

# Compact tip 33

## radiatoare-panou

PURMO C 33

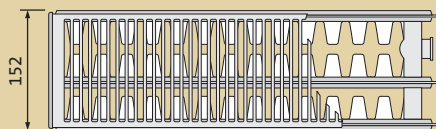

CODUL COMENZII : C33XXXXYYY

EXEMPLU : C336001200

abreviere denumire

tip

înălțime

lungime



lungime [mm]	parametri $t_z / t_p / t_i$	înălțime [mm]					
		300	450	500	550	600	900
400	75/65/20°C	539	748	814	879	942	1304
	70/55/20°C	431	596	649	700	750	1035
500	75/65/20°C	674	935	1018	1099	1178	1630
	70/55/20°C	539	746	811	875	937	1294
600	75/65/20°C	808	1121	1221	1318	1414	1956
	70/55/20°C	647	895	973	1050	1124	1553
700	75/65/20°C	943	1308	1425	1538	1649	2282
	70/55/20°C	754	1044	1135	1225	1312	1812
800	75/65/20°C	1078	1495	1628	1758	1885	2608
	70/55/20°C	862	1193	1298	1399	1499	2071
900	75/65/20°C	1212	1682	1832	1977	2120	2934
	70/55/20°C	970	1342	1460	1574	1687	2329
1000	75/65/20°C	1347	1869	2035	2197	2356	3260
	70/55/20°C	1078	1491	1622	1749	1874	2588
1100	75/65/20°C	1482	2056	2239	2417	2592	3586
	70/55/20°C	1186	1640	1784	1924	2061	2847
1200	75/65/20°C	1616	2243	2442	2636	2827	3912
	70/55/20°C	1293	1789	1946	2099	2249	3106
1400	75/65/20°C	1886	2617	2849	3076	3298	4564
	70/55/20°C	1509	2087	2271	2449	2624	3623
1600	75/65/20°C	2155	2990	3256	3515	3770	5216
	70/55/20°C	1724	2386	2595	2799	2999	4141
1800	75/65/20°C	2425	3364	3663	3955	4241	5868
	70/55/20°C	1940	2684	2919	3149	3373	4659
2000	75/65/20°C	2694	3738	4070	4394	4712	6520
	70/55/20°C	2156	2982	3244	3499	3748	5176
2300	75/65/20°C	3098	4299	4681	5053	5419	7498
	70/55/20°C	2479	3429	3730	4023	4310	5953
2600	75/65/20°C	3502	4859	5291	5712	6126	8476
	70/55/20°C	2802	3877	4217	4548	4873	6729
3000	75/65/20°C	4041	5607	6105	6591	7068	9780
	70/55/20°C	3233	4473	4866	5248	5622	7764

Puterea termică a radiatoarelor (W) în conformitate cu EN 442 pentru parametrii 75/65/20°C și 70/55/20°C.

[W/m] 90/70/20°C	1698	2363	2576	2784	2988	4143
coeficient n	1,3140	1,3313	1,3371	1,3428	1,3486	1,3600

radiator la comandă