

**FANS FOR ROUND DUCTS**

Series  
**VENTS VK**



In-line centrifugal fans in plastic casing with the air capacity up to **1700 m<sup>3</sup>/h**

**Applications**

VK fans are applied for supply and exhaust ventilation systems of commercial, office and other premises. Compatible with Ø 100, 125, 150, 200, 250 and 315 mm round air ducts. Models marked VK...Q are supplied with quiet motors for low-noise applications. Due to the corrosion-resistant durable plastic casing, these models are the perfect solution for the installation in exhaust ventilation systems in humid premises such as bathrooms, kitchens etc.

**Design**

The casing is made of high-quality durable ABS plastic. The fans are equipped with waterproof terminal boxes. Models marked VK..R are supplied with the power cord and a plug.

**Motor**

The impeller with backward curved blades is powered by a single-phase asynchronous AC motor with external rotor including the following features:

- ▶ A dynamic balanced impeller with backward curved blades balanced in two planes.

- ▶ Overheating protection with automatic restart.
- ▶ Maintenance-free ball-bearings used with motors and designed for at least 40 000 hours operation. Models marked VKS are supplied with high-powered motors. Motor protection rating IP 44.

**Speed control**

Smooth or stepped speed control can be performed by external thymistor or transformer. Several fans can be connected to one speed controller if the total power and operating current of fans do not exceed the rated controller values.

**Mounting**

Installation to the wall or ceiling can be performed by means of mounting brackets (included in the delivery) or with additional PVK holders (available upon request). The fan can be mounted at any angle. Electric connection and installation shall be performed in compliance with the manual and the wiring diagram on the terminal box.

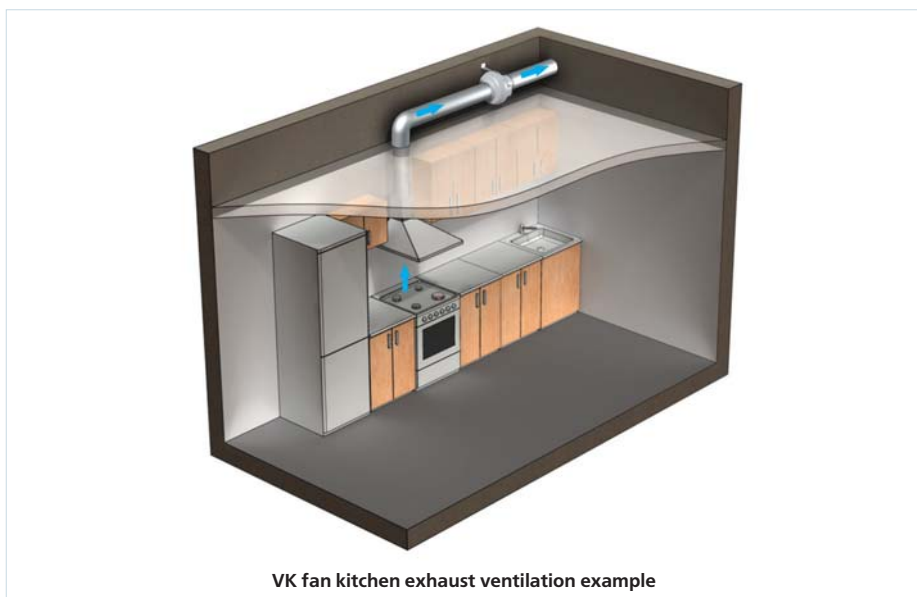

**VK fan kitchen exhaust ventilation example**

**Designation key:** \_\_\_\_\_

Fan series		Duct diameter	Additional options
<b>VENTS VK</b>	<b>S</b> – high-powered motor	100; 125; 150*; 200; 250; 315	<b>Q</b> – low-noise application; <b>U</b> – speed controller module with the built in temperature sensor; <b>Un</b> – speed controller module with the external temperature sensor; <b>U1</b> – speed controller with the built in timer and temperature sensor; <b>U1n</b> – speed controller with the built in timer and external temperature sensor; <b>R</b> – power cord and C14 plug.

\* VK 150 model is compatible with the air ducts both Ø 150 and 160 mm

**Accessories**



page 240    page 248    page 250    page 254    page 262    page 294    page 296    page 304    page 310    page 310    page 314    page 315

**Automatic speed control module**

VK..U1 and VK..U1n are the perfect solution for greenhouses and other premises requiring air temperature control. These models are fitted with an integrated electronic speed control module TSC with temperature sensor that provides automatic speed regulation as a function of air temperature in the duct (VK..U1 with integrated temperature sensor) or directly in the ventilated area (VK..U1n with external temperature sensor).

Temperature and minimum speed can be adjusted with two control knobs on the controller panel.

The external temperature sensor (in VK..Un and VK..U1n models) is supplied with 4 m cable and a protecting cover against mechanical damage. The LED indicator for thermostat operation is placed at the front panel of the fan.

**Automatic speed controller pattern for VK fans.**

Set points for the maximum air temperature and the fan speed are manually adjusted by the control knobs. Normally the fan operates with the speed which is set by the knob. If the temperature exceeds the set point, the fan boosts to the maximum speed. After that when the temperature drops down below the set point, the fan goes back to preset speed. The switching delay disables frequent motor switching if the set temperature in the duct is equal to the threshold temperature.

There are two patterns of delay that may be used in various cases:

1. Temperature sensor delay (VK..U): if the temperature rises by 2°C above the set thermostat operating threshold the motor switches to the

increased speed. The motor switches to the preset (low) speed as the temperature drops below the set threshold. This pattern can be used to keep air temperature to within 2°C. In this case the fan switches are rare.

2. Timer delay (VK..U1): the motor sets to higher speed 5 min after the temperature exceeds the set threshold. The motor switches to the preset (low) speed 5 min. after the temperature drops below the set threshold.

This pattern can be used to keep the air temperature at a precise level. In this case the fan switches more frequently than in the pattern of temperature sensor delay, but the intervals do not exceed 5 minutes.

**Example for temperature sensor delay pattern:**

Initial conditions:

- rated speed is set as 60% of the maximum speed
- operating threshold is set as 25°C
- air temperature in the duct is 20°C

motor operates with the rated speed =60%

- air temperature in the duct rises

motor operates with the rated speed =60%

- air temperature in the duct reaches 27°C

motor switches to the speed =100%

air temperature in the duct goes down

motor operates with the speed =100%

- temperature in the duct reaches 25°C again

motor switches to the preset rated speed =60%

**Example for timer delay pattern:**

Initial conditions:

- rated speed is set as 60% of maximum speed
- operating threshold is set as 25°C
- air temperature in the duct is 20°C

motor operates with the rated speed =60%

- the temperature in the duct rises, reaches 25°C and keeps rising

fan switches to the maximum speed =100% and the delay timer switches for 5 minutes again on

- the temperature in the duct goes down

the motor operates with the maximum speed =100%

- the temperature in the duct reaches 25°C and keeps rising

after the timer stops, the motor switches to the preset rated speed (=60%). After the speed switch the timer switches again for 5 minutes on.

- the temperature in the duct rises, reaches 25°C and keeps rising

after the timer stops, the motor switches to the maximum speed (=100%). After the speed switch the delay timer switches again for 5 minutes on.

Thus, in timer delay pattern the delay timer activates every time the fan speed changes.

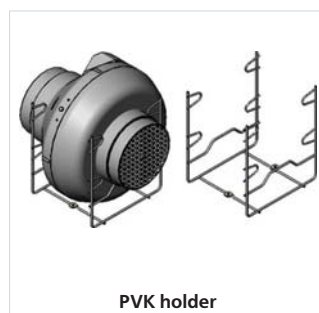

# FANS FOR ROUND DUCTS

## Technical data:

	VK 100 Q	VK 100	VK 125 Q	VK 125	VK 150	VK 200	VKS 200
Voltage [V / 50 Hz]	230	230	230	230	230	230	230
Power [W]	62	80	61	79	80	107	173
Current [A]	0,38	0,34	0,38	0,34	0,35	0,47	0,76
Maximum air flow [m <sup>3</sup> /h]	205	250	260	355	460	780	930
RPM [min <sup>-1</sup> ]	2650	2820	2610	2800	2725	2660	2125
Noise level at 3 m [dBA]	36	46	36	46	46	48	51
Maximum operating temperature [°C]	-25 +55	-25 +55	-25 +55	-25 +55	-25 +55	-25 +50	-25 +45
Protection rating	IP X4	IP X4	IP X4	IP X4	IP X4	IP X4	IP X4

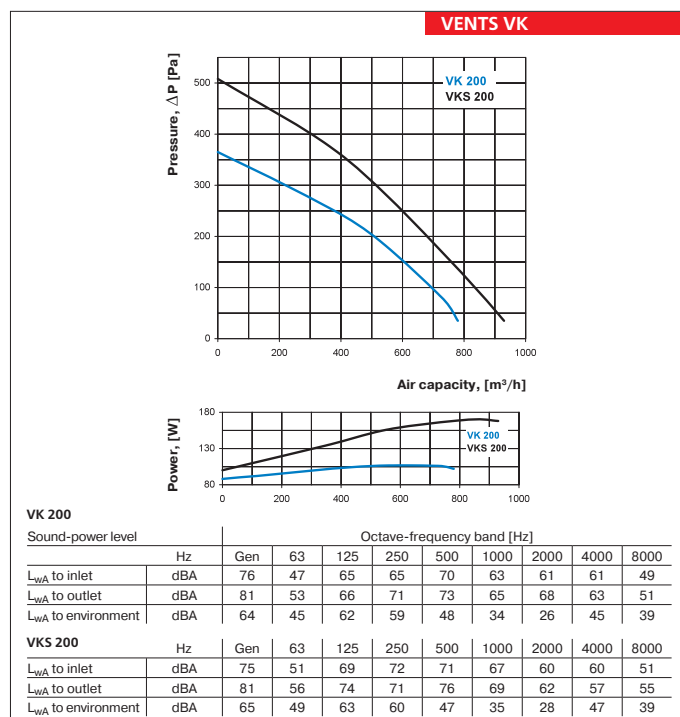
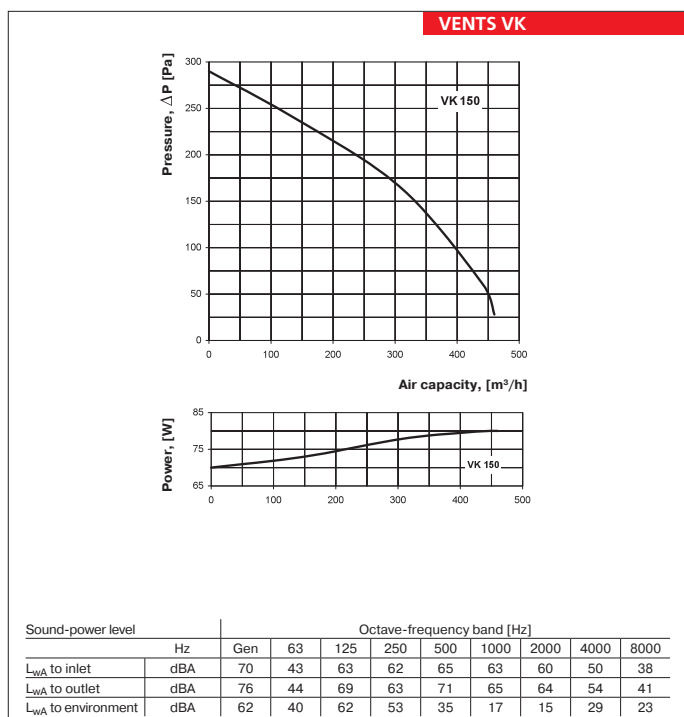
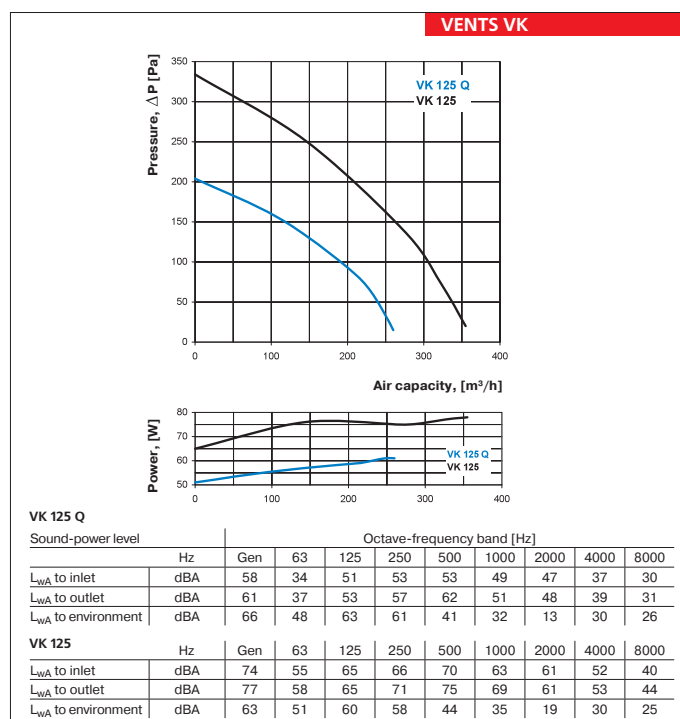
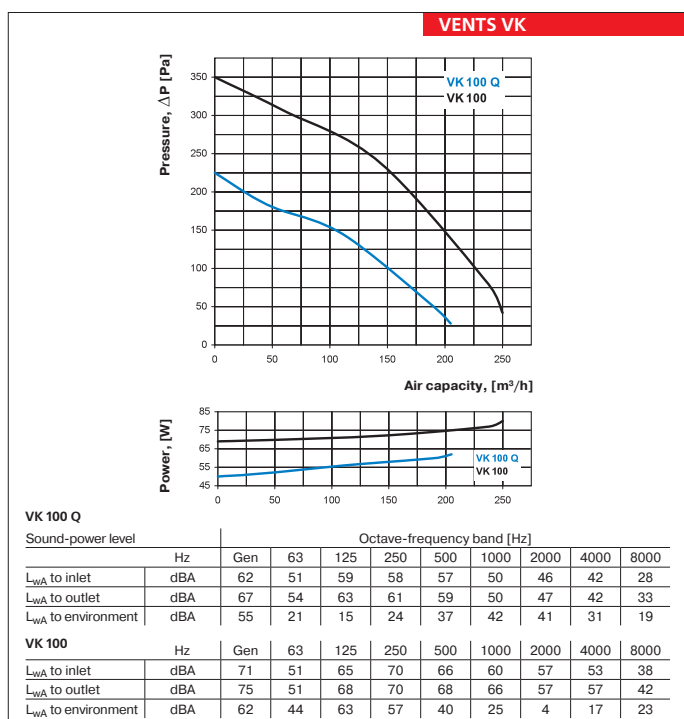

**Technical data:**

	VK 250 Q	VK 250	VK 315	VKS 315
Voltage [V / 50 Hz]	230	230	230	230
Power [W]	108	173	200	310
Current [A]	0,47	0,76	0,88	1,36
Maximum air flow [m <sup>3</sup> /h]	865	1080	1340	1700
RPM [min <sup>-1</sup> ]	2560	2090	2655	2590
Noise level at 3 m [dBA]	51	50	50	53
Maximum operating temperature [°C]	-25 +50	-25 +50	-25 +50	-25 +45
Protection rating	IP X4	IP X4	IP X4	IP X4

FAN SERIES VENTS VK

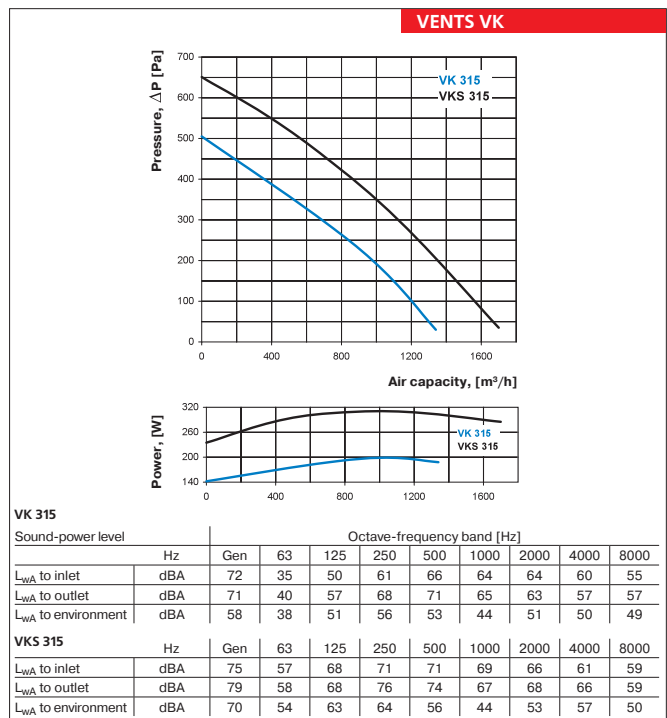
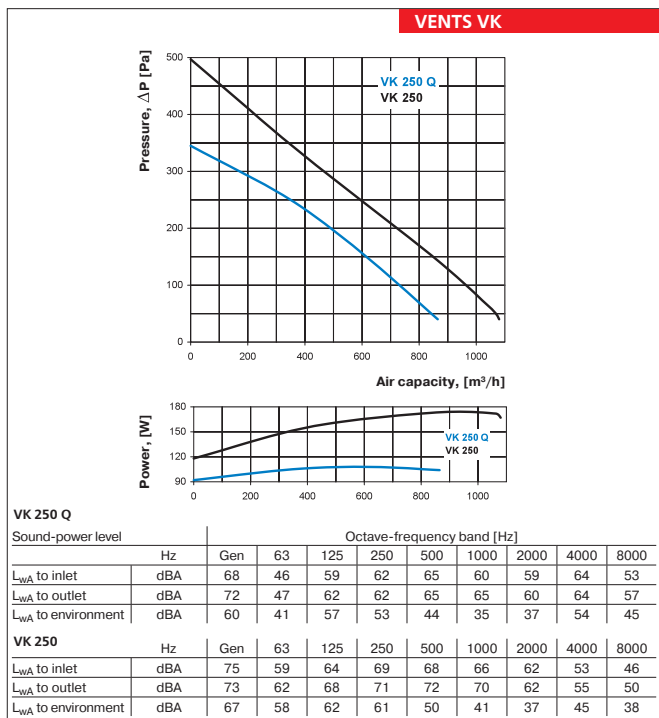

**Fan overall dimensions:**

Type	Dimensions [mm]								Mass [kg]
	∅D	∅D1	B	L	L1	L2	L3		
VK 100 Q / VK 100	100	250	270	230	30	27	30	2,15	
VK 125 Q / VK 125	125	250	270	220	30	27	30	2,2	
VK 150	150 / 160	300	310	286	30	30	30	2,6	
VK 200	200	340	354	276	30	30	40	4,0	
VKS 200	200	340	354	276	30	30	40	4,3	
VK 250 Q / VK 250	250	340	354	265	30	30	40	4,5	
VK 315	315	400	414	276	40	55	40	5,1	
VKS 315	315	400	414	276	40	55	40	5,2	

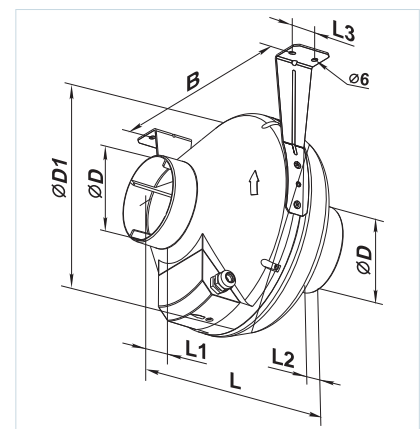

**CALOR SRL**

Str. Progresului nr. 30-40, sector 5, Bucuresti  
 tel: 021.411.44.44, fax: 021.411.36.14  
 www.calorserv.ro - www.calor.ro